

Manual Equipment Divider for Tomatoes - 4 portions

ITEM # _____

MODEL # _____

NAME # _____

SIS # _____

AIA # _____



601161 (DTAT4)

Divider for Tomatoes - 4 portions

Short Form Specification

Item No. _____

Manual table-top divider for cutting tomatoes, citrus and other fruits into segments of different sizes. It consists on an aluminium tripod base with 3 suction pads for stability and 2 stainless steel guiding rods, an aluminium pusher and a cutting block with stainless steel blades. All the elements are easily removable to be clean under running water. Pusher and cutting block are interchangeable, but they have to be properly combined. Their conical shape helps to centre the fruit to obtain identical segments.
Supplied with n.1 grid for 4 portions and n.1 pressure block for 4/8 portions.

Main Features

- Supplied with interchangeable attachments suitable for every requirement, 1 grid for 4 portions and 1 pressure block for 4/8 portions.
- Easy dismantling without any tools.
- Easy cleaning under running water.
- Table top divider including frame, pusher and cutting block.
- Pusher movement guided by two stainless steel shafts fixed onto the aluminum tripod stand.
- Pusher and cutting block conical shape helps to center the fruit and to cut identical segments.

APPROVAL: _____

Front

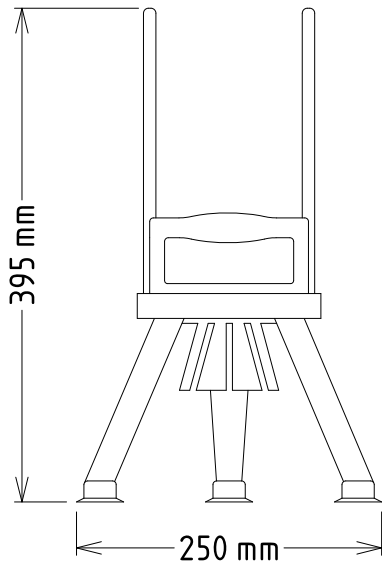

Side

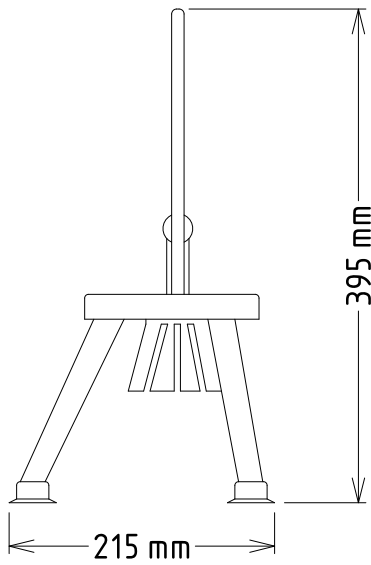

Top

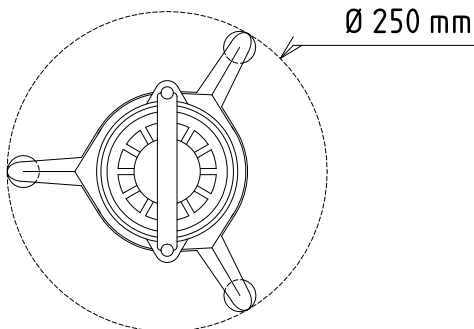

Key Information:

External dimensions, Width:	
601161 (DTAT4)	240 mm
External dimensions, Depth:	215 mm
External dimensions, Height:	395 mm
Shipping weight:	3 kg